

OPERATING INSTRUCTIONS

Memorex®

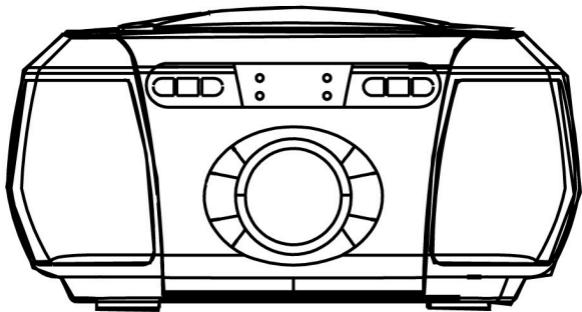

**PORTABLE STEREO CD-PLAYER
WITH AM/FM-STEREO RADIO**

MODEL : MP3109

Dear Customer,

Please read this manual thoroughly before operating the unit to become more familiar with it and obtain the performance that will bring you continued enjoyment for many years. Keep these instructions handy for future reference.

PLEASE KEEP ALL PACKAGING MATERIAL FOR AT LEAST 90 DAYS IN CASE YOU NEED TO RETURN THIS PRODUCT TO YOUR PLACE OF PURCHASE OR MEMOREX.

For future reference, record the serial number of the unit printed on the rear of the cabinet.

Serial Number _____

	CAUTION RISK OF ELECTRIC SHOCK DO NOT OPEN	
CAUTION: TO REDUCE THE RISK OF ELECTRIC SHOCK, DO NOT REMOVE COVER (OR BACK). NO USER-SERVICEABLE PARTS INSIDE. REFER SERVICING TO QUALIFIED SERVICE PERSONNEL.		

DANGEROUS VOLTAGE:

The lightning flash with arrowhead symbol, within an equilateral triangle is intended to alert the user to the presence of uninsulated dangerous voltage within the product's enclosure that may be of sufficient magnitude to constitute a risk of electric shock to persons.

**ATTENTION:**

The exclamation point within an equilateral triangle is intended to alert the user to the presence of important operating and maintenance (servicing) instructions in the literature accompanying the appliance.

**DANGER:**

Invisible and hazardous laser radiation when open and interlock failed or defeated. Avoid direct exposure to beam.

**FCC WARNING:**

This equipment may generate or use radio frequency energy. Changes or modifications to this equipment may cause harmful interference unless the modifications are expressly approved in the instruction manual. The user could lose the authority to operate this equipment if an unauthorized change or modification is made.

LASER SAFETY: This unit employs a laser. Only qualified service personnel should attempt to service this device due to possible eye injury.

CAUTION: USE OF CONTROLS, ADJUSTMENTS OR PERFORMANCE PROCEDURE HEREIN MAY RESULT IN HAZARDOUS RADIATION EXPOSURE.

INFORMATION:

This equipment has been tested and found to comply with the limits for a Class B digital device, pursuant to Part 15 of the FCC Rules.

These limits are designed to provide reasonable protection against harmful interference in a residential installation. This equipment generates, uses, and can radiate radio frequency energy and, if not installed and used in accordance with the instructions, may cause harmful interference to radio communications. However, there is no guarantee that interference will not occur in a particular installation. If this equipment does cause harmful interference to radio or television reception, which can be determined by turning the equipment off and on, the user is encouraged to try to correct the interference by one or more of the following measures:

- Reorient or relocate the receiving antenna.
- Increase the separation between the equipment and receiver.
- Connect the equipment into an outlet on a circuit different from that to which the receiver is connected.
- Consult the dealer or an experienced radio/ TV technician for help.

WARNING: TO PREVENT FIRE OR SHOCK HAZARD, DO NOT EXPOSE THIS UNIT TO RAIN OR MOISTURE.

SURGE PROTECTORS:

It is recommended to use a surge protector for AC connection. Lightning and power surges ARE NOT covered under warranty for this product.

Dear Customer:

Selecting fine audio equipment such as the unit you've just purchased is only the start of your musical enjoyment. Now it's time to consider how you can maximize the fun and excitement your equipment offers. This manufacturer and the Electronic Industries Association's Consumer Electronics Group want you to get the most out of your equipment by playing it at a safe level. One that lets the sound come through loud and clear without annoying blaring or distortion and, most importantly, without affecting your sensitive hearing. Sound can be deceiving. Over time your hearing "comfort level" adapts to higher volumes of sound. So what sounds "normal" can actually be loud and harmful to your hearing. Guard against this by setting your equipment at a safe level BEFORE your hearing adapts.

To establish a safe level:

- Start your volume control at a low setting.
- Slowly increase the sound until you can hear it comfortably and clearly, and without distortion.

Once you have established a comfortable sound level:

- Set the dial and leave it there.

Taking a minute to do this now will help to prevent hearing damage or loss in the future. After all, we want you listening for a lifetime.

We Want You Listening For A Lifetime

Used wisely, your new sound equipment will provide a lifetime of fun and enjoyment. Since hearing damage from loud noise is often undetectable until it is too late, this manufacturer and the Electronic Industries Association's Consumer Electronics Group recommend you avoid prolonged exposure to excessive noise. This list of sound levels is included for your protection.

Decibel

Level	Example
30	Quiet library, soft whispers
40	Living room, refrigerator, bedroom away from traffic
50	Light traffic, normal conversation, quiet office
60	Air conditioner at 20 feet, sewing machine
70	Vacuum cleaner, hair dryer, noisy restaurant
80	Average city traffic, garbage disposals, alarm clock at two feet

THE FOLLOWING NOISES CAN BE DANGEROUS UNDER CONSTANT EXPOSURE:

90	Subway, motorcycle, truck traffic, lawn mower
100	Garbage truck, chain saw, pneumatic drill
120	Rock band concert in front of speakers, thunderclap
140	Gunshot blast, jet engine
180	Rocket launching pad

Information courtesy of the Deafness Research Foundation.



SAFETY INSTRUCTIONS

Before using the unit, be sure to read all operating instructions carefully. Please note that these are general precautions and may not pertain to your unit. For example, this unit may not have the capability to be connected to an outdoor antenna.

1. READ INSTRUCTIONS

All the safety and operating instructions should be read before the product is operated.

2. RETAIN INSTRUCTIONS

The safety and operating instructions should be retained for future reference.

3. HEED WARNINGS

All warnings on the product and in the operating instructions should be adhered to.

4. FOLLOW INSTRUCTIONS

Operating and use instructions should be followed.

5. CLEANING

Unplug this product from the wall outlet before cleaning. Do not use liquid cleaners or aerosol cleaners. Use a damp cloth for cleaning.

6. ATTACHMENTS

Do not use attachments not recommended by the product's manufacturer as they may cause hazards.

7. WATER AND MOISTURE

Do not use this product near water- for example, near a bathtub, washbowl, kitchen sink, or laundry tub, in a wet basement, or near a swimming pool.

8. ACCESSORIES

Do not place this product on an unstable cart, stand, tripod, bracket, or table. The product may fall, causing serious injury and serious damage to the product. Use only with a cart, stand, tripod, bracket, or table recommended by the manufacturer or sold with the product. Any mounting of the product should follow the manufacturer's instructions, and should use a recommended by the manufacturer.

8A. An appliance and cart combination should be moved with care. Quick stops, excessive force, and uneven surfaces may cause the appliance and cart combination to overturn.

9. VENTILATION

Slots and openings in the cabinet and in the back or bottom are provided for ventilation and to ensure reliable operation of the product and to protect it from overheating. These openings must not be blocked or covered. The openings should never be blocked by placing the product on a bed, sofa, rug, or other similar surface. This product should never be placed near or over a radiator or heat source. This Product should not be placed in a built-in installation such as a bookcase or rack unless proper ventilation is provided or the manufacturer's instructions have been adhered to.

10. POWER SOURCES

This product should be operated only from the type of power source indicated on the marking label. If you are not sure of the type of power source indicated on the marking label. If you are not sure of the type of power supply to your home, consult your appliance dealer or local power company. For products intended to operate from battery power, or other sources, refer to the operating instructions.

11. GROUNDING OR POLARIZATION

This product is equipped with a polarized alternating-current line plug (a plug having one blade wider than the other). This plug will fit into the power outlet only one way. This is a safety feature. If you are unable to insert the plug fully into the outlet, try reversing the plug. If the plug should still fail to fit, contact your electrician to replace your obsolete outlet. Do not defeat the safety purpose of the polarized plug.

12. POWER-CORD PROTECTION

Power-supply cords should be routed so that they are not likely to be walked on or pinched by items placed upon or against them, paying particular attention to cords at plugs, convenience receptacles, and the point where they exit from the appliance.

13. LIGHTNING

To protect your product from a lightning storm, or when it is left unattended and unused for long periods of time, unplug it from the wall outlet and disconnect the antenna or cable system. This will prevent damage to the product due to lightning and power-line surges.

14. POWER LINES

An outside antenna system should not be located in the vicinity of overhead power lines or other electric light or power circuits, or where it can fall into such power lines or circuits. When installing an outside antenna system, extreme care should be taken to keep from touching such power lines or circuits as contact with them might be fatal.

15. OVERLOADING

Do not overload wall outlets and extension cords as this can result in a risk of fire or electric shock.

16. OBJECT AND LIQUID ENTRY

Never push objects of any kind into this product through openings as they may touch dangerous voltage points or short out parts that could result in fire or electric shock. Never spill or spray any type of liquid on the product.

17. OUTDOOR ANTENNA GROUNDING

If an outside antenna is connected to the product, be sure the antenna system is grounded so as to provide some protection against voltage surges and built-up static charges. Section 810 of the National Electric Code, ANSI/NFPA 70, provides information with respect to proper grounding of the mast and supporting structure, grounding of the lead-in wire to an antenna discharge product, size of grounding conductors, location of antenna discharge product, connection to grounding electrodes, and requirements for grounding electrode.

PORTABLE CART WRING
(symbol provided by RETAC)

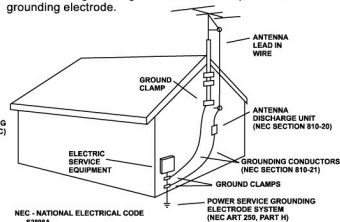

EXAMPLE OF ANTENNA GROUNDING AS PER NATIONAL ELECTRICAL CODE

18. SERVICING

Do not attempt to service this product yourself as opening or removing covers may expose you to dangerous voltage or other hazards. Refer all servicing to qualified service personnel.

19. REPLACEMENT PARTS

When replacement parts are required, be sure the service technician uses replacement parts specified by the manufacturer or those that have the same characteristics as the original part. Unauthorized substitutions may result in fire, electric shock or other hazards.

20. SAFETY CHECK

Upon completion of any service or repairs to this product, ask the service technician to perform safety checks to determine that the product is in proper operating condition.

21. WALL OR CEILING MOUNTING

The product should be mounted to a wall or ceiling only as recommended by the manufacturer.

22. DAMAGE REQUIRING SERVICE

- Unplug the product from the wall outlet and refer servicing to qualified service personnel under the following conditions:
- When the power-supply cord or plug is damaged.
 - If liquid has been spilled, or objects have fallen into the product.
 - If the product has been exposed to rain or water.
 - If the product does not operate normally by following the operating instructions. Adjust only those controls that are covered by the operating instructions, as an adjustment or other controls may result in damage and will often require extensive work by a qualified technician to restore the product to its normal operation.
 - If the product has been dropped or the cabinet has been damaged.
 - When the product exhibits a distinct change in performance - this indicates a need for service.

23. HEAT

The product should be situated away from heat sources such as radiators, heat registers, stoves, or other products (including amplifiers) that produce heat.

24. NOTE TO CATV SYSTEM INSTALLER

This reminder is provided to call the CATV system installer's attention to Article 820-40 of the NEC that provides guidelines for proper grounding and, in particular, specifies that the cable ground shall be connected to the grounding system of the building, as close to the point of cable entry as practical.

TOP-VIEW

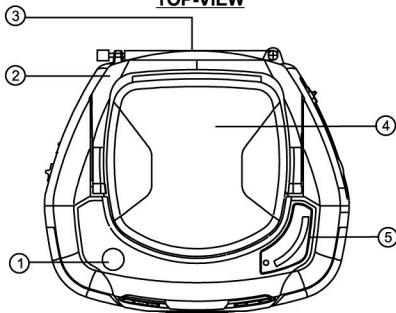

LEFT-SIDE VIEW

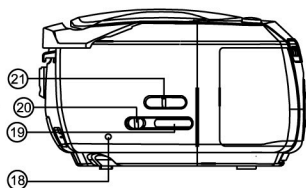

FRONT-VIEW

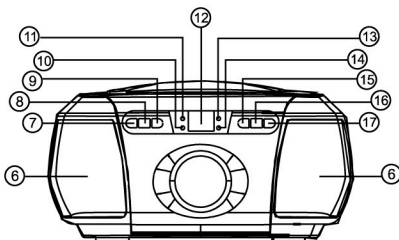

RIGHT-SIDE VIEW

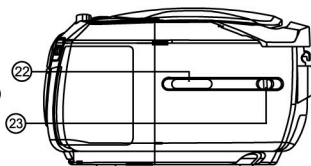

LOCATION OF CONTROLS

1. CD-DOOR OPEN BUTTON

2. HANDLE

3. TELESCOPIC ANTENNA

4. CD-DOOR

5. RADIO DIAL SCALE

6. SPEAKER (LEFT & RIGHT)

7. CD PROGRAM BUTTON

8. CD PLAY/PAUSE BUTTON

9. CD STOP BUTTON

10. PROGRAM LED INDICATOR

11. POWER LED INDICATOR

12. CD-DISPLAY

13. REPEAT LED INDICATOR

14. PLAY/PAUSE LED INDICATOR

15. CD SKIP-BACK BUTTON

16. CD REPEAT BUTTON

17. CD SKIP-NEXT BUTTON

18. HEADPHONE (EARPHONE) JACK

19. VOLUME KNOB

20. BASS BOOST ON/OFF SWITCH

21. FUNCTION SWITCH (CD/RADIO/OFF)

22. TUNING KNOB

23. RADIO BAND SELECTOR SWITCH

POWER SUPPLY

BATTERY OPERATION

- OPEN THE BATTERY DOOR AND INSERT 6 PCS "C-CELL" (UM-2/LR14 TYPE) BATTERIES. PLEASE OBSERVE CORRECT BATTERY POLARITIES OR THE SET WILL NOT WORK.
- IMPORTANT: WHEN THE SET IS ONLY USED WITH AC, OR IS NOT USED FOR 4 WEEKS OR MORE, PLEASE REMOVE THE BATTERIES, TO AVOID DAMAGE TO THE SET FROM LEAKAGE OF BATTERIES.

BOTTOM VIEW

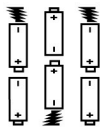
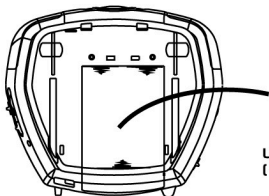

UM-2 / "C" / LR14
(1.5V) SIZE x 6 PCS

AC OPERATION (BUILT-IN TRANSFORMER)

- MAKE SURE THE SET VOLTAGE OF THE UNIT MATCHES YOUR LOCAL HOUSEHOLD VOLTAGE 120V / 60Hz.
- INSERT THE TAIL-END OF THE AC-CORD INTO THE AC-SOCKET AT THE REAR OF THE SET.
- INSERT THE PLUG OF THE AC-CORD INTO A WALL OUTLET WITH AC-POWER.

IMPORTANT!

PLEASE MAKE SURE TO SET THE FUNCTION SWITCH (21) TO "POWER OFF" POSITION WHEN UNIT IS NOT IN USE TO CONSERVE POWER.

OPERATION OF RADIO

- SET THE FUNCTION SWITCH TO "RADIO" AND THE BAND SELECTOR SWITCH TO THE DESIRED BAND.
- ROTATE TUNING KNOB TO TUNE-IN THE DESIRED STATION.
- ADJUST THE TELESCOPIC ANTENNA AND POSITION OF THE SET TO OBTAIN THE BEST RECEPTION.
- ADJUST THE VOLUME KNOB TO THE DESIRED LEVEL.
- TO TURN OFF THE RADIO, SLIDE THE FUNCTION SWITCH TO "POWER OFF".







HEADPHONE JACK

- THIS UNIT IS EQUIPPED WITH A STEREO HEADPHONE JACK (3.5MM DIAMETER) WHICH ACCEPTS MOST STANDARD STEREO EARPHONES & HEADPHONES (NOT INCLUDED).
- WHEN THE PLUG OF A STANDARD STEREO HEADPHONE (OR EARPHONE) IS INSERTED INTO THIS JACK, THE BUILT-IN SPEAKERS WILL AUTOMATICALLY BE DISABLED.
- WHEN THE HEADPHONE/EARPHONE IS DISCONNECTED, THE SPEAKERS WILL BE RE-ACTIVATED.

INSERTION & REMOVAL OF DISCS

- WHEN OPENING THE CD-DOOR, ALWAYS ENSURE THE DISC IS NOT IN MOTION (NOT SPINNING) WHEN YOU PRESS THE "OPEN" BUTTON. ALWAYS PRESS "STOP" BUTTON TO STOP THE DISC SPINNING FIRST.
- PLACE A CD INTO THE CD COMPARTMENT WITH THE LABEL-SIDE (PRINTED SIDE OF DISC) FACING UPWARDS.
- WHEN THE CD HAS BEEN PLACED ONTO THE CENTRE SPINDLE, GENTLY CLOSE THE CD-DOOR UNTIL IT LOCKS. WHILE CLOSE THE DOOR, YOU MAY HEAR THE CD AUTOMATICALLY BEING CENTERED & LOCKED INTO ITS PROPER POSITION BY THE DOOR MECHANISM & MAGNET.
- THE CD IS NOW READY TO BE PLAYED.
- TO REMOVE A DISC, FOLLOW THE SAME PROCEDURE AS DESCRIBED ABOVE, EXCEPT TO REMOVE THE CD INSTEAD OF INSERTING IT INTO THE COMPARTMENT.
- IMPORTANT : ALWAYS HOLD A CD BY IT'S EDGES. AVOID GETTING ANY FINGER-PRINTS, SMUDGES OR DIRT ONTO THE SURFACE OF A DISC. IN CASE THIS HAPPENS, USE A SPECIAL CD-CLEANING CLOTH OR CLEANING KIT TO REMOVE THE DIRT OR SMUDGES.

NORMAL CD OPERATION









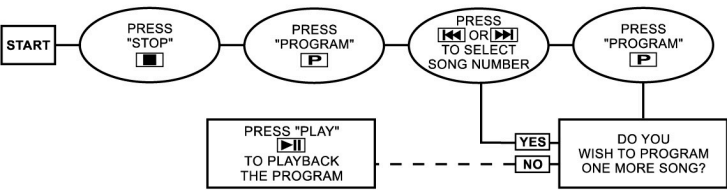



- INSERT A CD AS DESCRIBED. SET THE FUNCTION SWITCH TO "CD" POSITION.
- CLOSE THE CD-DOOR THE UNIT WILL IMMEDIATELY READ THE DISC AND DISPLAY THE NUMBER OF SONGS (TRACKS) ON THE CD.
- PRESS THE PLAY/PAUSE BUTTON  . THE DISK WILL START SPINNING AND THE FIRST SONG (TRACK) WILL START PLAYING. THE DISPLAY WILL INDICATE THE CURRENT TRACK NUMBER. ("1" IF IT IS THE FIRST TRACK).
- AT ANYTIME DURING PLAYBACK, PRESS THE "PLAY/PAUSE" BUTTON  TO PAUSE OPERATION OF THE UNIT. PRESS PLAY/PAUSE BUTTON AGAIN TO RESUME OPERATION AT THE SAME TRACK AND POSITION.
- AT ANYTIME DURING PLAYBACK, PRESS THE "STOP" BUTTON  TO STOP CD PLAYING.
- AT ANYTIME DURING PLAYBACK, "PRESS AND RELEASE" THE SEEK/SCAN BUTTON :  OR  TO SKIP BACKWARDS OR FORWARDS BY ONE TRACK, AS DESIRED.
- AT ANYTIME DURING PLAYBACK, "PRESS AND HOLD" THE SEEK/SCAN BUTTON :  OR  TO FAST-REVERSE (REVIEW) OR FAST-FORWARD (FORWARD) THE SPECIFIC TRACK, WHICH IS CURRENTLY PLAYING.
- AT ANYTIME DURING PLAYBACK, PRESS THE "CD REPEAT SWITCH" AS FOLLOWS:
 - PRESS ONCE = TO REPEAT THE CURRENT TRACK
(REPEAT LED INDICATOR WILL "FLASH")
 - PRESS TWICE = TO REPEAT ALL TRACKS (FULL CD)
(REPEAT LED INDICATOR WILL LIGHT "ON")

PROGRAMMING THE CD-PLAYER

- THE CD PLAYER CAN BE PROGRAMMED TO PLAY ANY SEQUENCE OF UP TO 16 TRACKS, AS DESIRED.

PROGRAMMING PROCEDURE AT A GLANCE:



- ALWAYS PRESS THE STOP  SWITCH BEFORE STARTING THE PROGRAMMING.
- PRESS THE PROGRAM SWITCH , THE DISPLAY WILL SHOW A FLASHING  AND THE "PROGRAM" LED INDICATOR WILL ALSO FLASH, TO INDICATE THAT THE SET IS NOW IN "MEMORY PROGRAMMING MODE".
- PRESS THE SEEK/SCAN SWITCHES  OR  TO SELECT THE TRACK (SONG) NUMBER YOU WISH TO BE STORED IN THE FIRST MEMORY (PROGRAM) POSITION, AND PRESS  (PROGRAM) TO CONFIRM YOUR SELECTION.
- WHEN YOU PRESS  THE DISPLAY WILL SHOW AGAIN  (FLASHING).
- REPEAT THE PREVIOUS 2 STEPS, EACH TIME SELECTING ANY TRACK NUMBER OF YOUR CHOICE TO BE STORED IN THE SUCCESSIVE MEMORY (PROGRAM) POSITIONS.
- AFTER EACH TRACK NUMBER, REMEMBER TO PRESS THE PROGRAM SWITCH .
- AFTER A MAXIMUM OF 16 SONGS (OR LESS) HAVE BEEN SELECTED AS DESCRIBED ABOVE, PRESS THE .
- THE DISPLAY WILL NOW SHOW INDICATE THE EXACT SONG SEQUENCE IN MEMORY BY DISPLAYING ALL THE SONG NUMBERS RAPIDLY.
- ALSO, THE "PROGRAM" LED-LIGHT WILL REMAIN "ON" TO INDICATE THAT YOU HAVE SAVED A PROGRAM-MEMORY (SEQUENCE).
- PRESSING PLAY  WILL NOW PLAY BACK THE "SAVED SEQUENCE" IN THE PROGRAM MEMORY.
- TO CLEAR (CANCEL) THE ENTIRE PROGRAM WHICH IS STORED IN THE MEMORY, SIMPLY PRESS "STOP"  TWICE, OR SWITCH "OFF" THE SET.

Caring for compact Discs

- Treat the compact disc carefully. Handle the compact disc only by its edges. Never allow your fingers to come in contact with the shiny, unprinted side of the compact disc.
- Do not attach adhesive tape, stickers, etc. to the compact disc label.
- Clean the compact disc periodically with a soft, lint-free, dry cloth. Never use detergents or abrasive cleaners to clean the compact disc. If necessary, use a CD cleaning kit.
- If a disc skips or gets stuck on a section of the compact disc, it is probably dirty or damaged (scratched).
- When cleaning the compact disc, wipe in straight lines from the center of compact disc to the outer edge of the compact disc. Never wipe in circular motions.

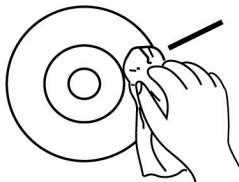
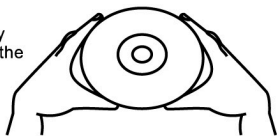

- This unit is designed to play only compact discs bearing the identification logo as shown here. Other discs may not conform to the CD standard and may not play properly.
- Compact discs should be stored in their cases after each use to avoid damage.
- Do not expose compact discs to direct sunlight, high humidity, high temperatures, or dust, etc. Prolonged exposure or extreme temperatures can warp the compact disc.
- Do not stick or write anything on either side of the compact disc. Sharp writing instruments, or the ink may damage the surface.



Cleaning the unit

- To prevent fire or shock hazard, disconnect your unit from the AC power source when cleaning.
- The finish on your unit may be cleaned with a dust cloth and cared for as other furniture. Use caution when cleaning and wiping the plastic parts.
- Mild soap and a damp cloth may be used on the front panel.

TROUBLESHOOTING GUIDE

Should this unit exhibit a problem, check the following before seeking service:

Symptom	Possible Cause	Solution
Radio		
Noise or sound distorted on radio broadcasts.	Station not tuned properly for AM or FM.	Retune the AM or FM broadcast station.
	FM: Antenna is not properly adjusted.	Reorient FM Antenna.
	AM: Unit is not positioned correctly.	Rotate unit until best reception is obtained.
FM station not heard in stereo.	Poor FM signal being received or Function switch is not set to FM stereo position.	Retune station, try another station or set switch to FM stereo position.
	Station is not broadcasting in stereo.	Change stations.
AM or FM, no sound	Function switch is not set to the AM or FM position.	Slide the Function switch to the AM or FM position.
	Volume at minimum.	Increase volume.
Compact Disc Player		
CD Player will not play.	Function switch is not set to the CD position.	Set Function switch to the CD position.
	CD is not installed or installed upside-down.	Insert CD with label side up.
CD skips while playing.	Disc is dirty or scratched.	Wipe disc with cloth (see page 10 or use another disc).
General		
No power.	Function switch is not set to the correct position.	Set Function switch to the correct position, as desired.
	AC plug is not inserted properly.	Connect AC power cord to AC wall outlet and jack on rear of unit. Make sure the plug is inserted securely.
	Batteries are not inserted properly.	Make sure the batteries are inserted according to the polarity inside the battery compartment.
	Batteries are dead or weak.	Replace batteries.

FOR ADDITIONAL SET-UP OR OPERATING ASSISTANCE, PLEASE VISIT OUR WEBSITE AT WWW.MEMCORPINC.COM
OR CONTACT CUSTOMER SERVICE AT 1-800-919-3647.
PLEASE KEEP ALL PACKAGING MATERIAL FOR AT LEAST 90 DAYS IN CASE YOU NEED TO RETURN THIS PRODUCT TO YOUR PLACE OF PURCHASE OR MEMOREX. FOR PARTS AND ACCESSORIES, CONTACT FOX INT'L AT 1-800-321-6993

SPECIFICATIONS

GENERAL:

Power Source AC 120V \sim , 60Hz
Battery 9V DC  (6 x C-Cell / LR14 / UM-2 Size)
(Batteries not included)
Alkaline is recommended for longer life
Speaker 4 Ohms
Output Power 2 W @ 10% THD

RADIO SECTION:

Frequency Range (FM) 88 - 108 MHz
Frequency Range (AM) 530 - 1710 kHz

CD SECTION:

Disc Diameter 4.72" (120mm)
3.15" (80mm) Single CD
Optical Source Semiconductor Laser

Specifications are subject to change without notice.

Memcorp, Inc.

Weston, FL

Printed in Hong Kong

Visit our website at www.memcorpinc.com